

Ultra High Speed Operational Amplifier

FEATURES

- Gain Bandwidth Product, $A_V = +5$ 350MHz
- Slew Rate 450V/ μ s
- Low Cost
- Output Current ± 50 mA
- Settling Time 90ns to 0.1%
- Differential Gain Error 0.1% ($R_L = 1k\Omega$)
- Differential Phase Error 0.01° ($R_L = 1k\Omega$)
- High Open Loop Gain 125V/mV Min
- Single Supply +5V Operation
- Output Shutdown

APPLICATIONS

- Video Cable Drivers
- Video Signal Processing
- Photo-Diode Amplifier
- Pulse Amplifiers
- D/A Current to Voltage Conversion

DESCRIPTION

The LT1192 is a video operational amplifier optimized for operation on ± 5 V, and a single +5V supply. Unlike many high speed amplifiers, this amplifier features high open loop gain, over 100dB, and the ability to drive heavy loads to a full power bandwidth of 20MHz at 7Vp-p. In addition to its very fast slew rate, the LT1192 has a high gain bandwidth of 350MHz, and is compensated for a closed loop gain of 5 or greater.

Because the LT1192 is a true operational amplifier, it is an ideal choice for wideband signal conditioning, active filters, and applications requiring speed, accuracy, and low cost.

The LT1192 is available in 8-pin miniDIPs and SO packages with standard pinouts. The normally unused pin 5 is used for a shutdown feature that shuts off the output and reduces power dissipation to a mere 15mW.

Double Terminated Cable Driver

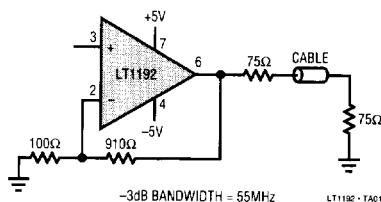

Inverter Pulse Response

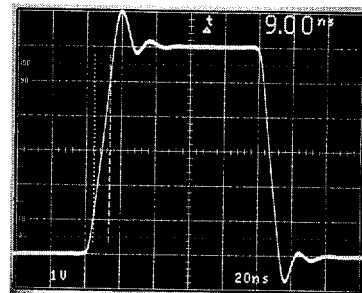

$A_V = -5$, $C_L = 10$ pF SCOPE PROBE

LT1192 - TA02

SIMPLIFIED SCHEMATIC

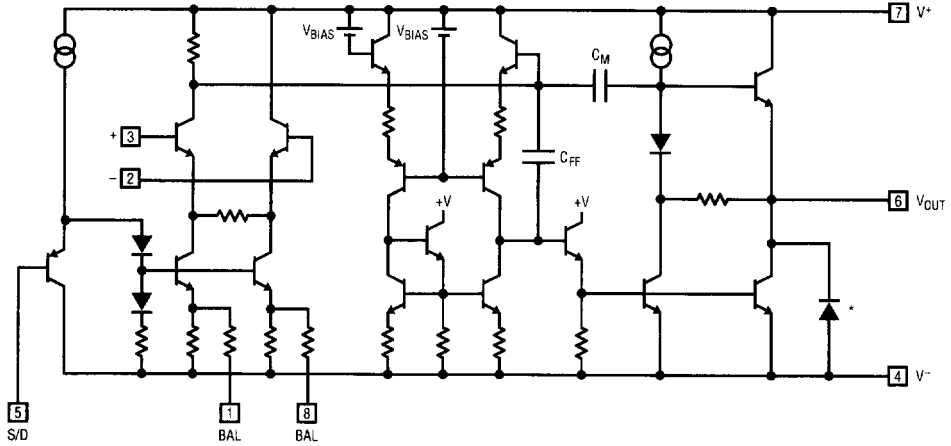

2

* SUBSTRATE DIODE, DO NOT FORWARD BIAS

LT1191 - TA14

ABSOLUTE MAXIMUM RATINGS

Total Supply Voltage (V^+ to V^-) 18V
 Differential Input Voltage $\pm 6V$
 Input Voltage $\pm V_S$
 Output Short Circuit Duration (Note 1) Continuous
 Operating Junction Temperature Range
 LT1192M $-55^\circ C$ to $150^\circ C$
 LT1192C $0^\circ C$ to $150^\circ C$
 Max. Junction Temperature See Pkg. Descriptions
 Storage Temperature Range $-65^\circ C$ to $150^\circ C$
 Lead Temperature (Soldering, 10 sec.) $300^\circ C$

PACKAGE/ORDER INFORMATION

	ORDER PART NUMBER
	LT1192MJ8 LT1192CJ8 LT1192CN8 LT1192CS8
	S8 PART MARKING
	1192

2

ELECTRICAL CHARACTERISTICS

$V_S = \pm 5V$, $T_A = 25^\circ C$, $C_L \leq 10pF$, pin 5 open circuit unless otherwise noted.

SYMBOL	PARAMETER	CONDITIONS	LT1192M/C			UNITS
			MIN	TYP	MAX	
V_{OS}	Input Offset Voltage			0.2	2.5	mV
I_{OS}	Input Offset Current			0.2	1.7	μA
I_B	Input Bias Current			± 0.5	± 2.5	μA
e_n	Input Noise Voltage	$f_0 = 10kHz$		9.0		nV/\sqrt{Hz}
i_n	Input Noise Current	$f_0 = 10kHz$		4.0		pA/\sqrt{Hz}
R_{IN}	Input Resistance	Differential Mode		16		$k\Omega$
		Common Mode		5.0		$M\Omega$
C_{IN}	Input Capacitance	$A_V = +10$		1.8		pF
	Input Voltage Range	(Note 2)	-2.5		+3.5	V
CMRR	Common Mode Rejection Ratio	$V_{CM} = -2.5V$ to $+3.5V$	70	85		dB
PSRR	Power Supply Rejection Ratio	$V_S = \pm 2.375V$ to $\pm 8.0V$	70	85		dB
A_{VOL}	Large Signal Voltage Gain	$R_L = 1k$, $V_O = \pm 3.0V$	100	180		V/mV
		$R_L = 100\Omega$, $V_O = \pm 3.0V$	16	35		
		$V_S = \pm 8V$, $R_L = 100\Omega$, $V_O = \pm 5V$	20	60		
V_{OUT}	Output Voltage Swing	$V_S = \pm 5V$, $R_L = 1k$	± 3.7	± 4.0		V
		$V_S = \pm 8V$, $R_L = 1k$	± 6.7	± 7.0		
SR	Slew Rate	$A_V = -10$, $R_L = 1k$, (Note 3, 8)	325	450		V/ μs
FPBW	Full Power Bandwidth	$V_O = 6V_{p-p}$, (Note 4)	17.2	23.9		MHz
GBW	Gain Bandwidth Product			350		MHz
t_{r1} , t_{f1}	Rise Time, Fall Time	$A_V = +50$, $V_O = \pm 1.5V$, 20% to 80%, (Note 8)	23	35	50	ns
t_{r2} , t_{f2}	Rise Time, Fall Time	$A_V = +5$, $V_O = \pm 125mV$, 10% to 90%		2.7		ns
t_{PD}	Propagation Delay	$A_V = +5$, $V_O = \pm 125mV$, 50% to 50%		3.5		ns
	Overshoot	$A_V = +5$, $V_O = \pm 125mV$		50		%
t_s	Settling Time	3V Step, 0.1%, (Note 5)		90		ns
Diff A_V	Differential Gain	$R_L = 150\Omega$, $A_V = +10$, (Note 6)		0.23		%
Diff Ph	Differential Phase	$R_L = 150\Omega$, $A_V = +10$, (Note 6)		0.15		Deg. p-p

ELECTRICAL CHARACTERISTICS $V_S = \pm 5V$, $T_A = 25^\circ C$, $C_L \leq 10pF$, pin 5 open circuit unless otherwise noted.

SYMBOL	PARAMETER	CONDITIONS	LT1192M/C			UNITS
			MIN	TYP	MAX	
I_S	Supply Current			32	38	mA
	Shutdown Supply Current	Pin 5 at V^-		1.3	2.0	
$I_{S/D}$	Shutdown Pin Current	Pin 5 at V^-		20	50	μA
t_{on}	Turn On Time	Pin 5 from V^- to Ground, $R_L = 1k$		100		ns
t_{off}	Turn Off Time	Pin 5 from Ground to V^- , $R_L = 1k$		400		ns

ELECTRICAL CHARACTERISTICS

$V_{S+} = +5V$, $V_{S-} = 0V$, $V_{CM} = +2.5V$, $T_A = 25^\circ C$, $C_L \leq 10pF$, pin 5 open circuit unless otherwise noted.

SYMBOL	PARAMETER	CONDITIONS	LT1192M/C			UNITS
			MIN	TYP	MAX	
V_{OS}	Input Offset Voltage			0.4	4.0	mV
I_{OS}	Input Offset Current			0.2	1.2	μA
I_B	Input Bias Current			± 0.5	± 1.5	μA
	Input Voltage Range	(Note 2)	+2.0		+3.5	V
CMRR	Common Mode Rejection Ratio	$V_{CM} = +2.0V$ to $+3.5V$	60	80		dB
A_{VOL}	Large Signal Voltage Gain	$R_L = 100\Omega$ to Ground, $V_O = +1.0V$ to $+3.0V$	30	50		V/mV
V_{OUT}	Output Voltage Swing	$R_L = 100\Omega$ to Ground	V_{OUT} High	3.6	3.8	V
			V_{OUT} Low		0.25	
SR	Slew Rate	$A_V = -5$, $V_O = +1V$ to $+3V$		250		V/ μs
GBW	Gain Bandwidth Product			350		MHz
I_S	Supply Current			29	36	mA
	Shutdown Supply Current	Pin 5 at V^-		1.2	2.0	
$I_{S/D}$	Shutdown Pin Current	Pin 5 at V^-		20	50	μA

ELECTRICAL CHARACTERISTICS $V_S = \pm 5V$, $-55^\circ C \leq T_A \leq 125^\circ C$, pin 5 open circuit unless otherwise noted.

SYMBOL	PARAMETER	CONDITIONS	LT1192M			UNITS
			MIN	TYP	MAX	
V_{OS}	Input Offset Voltage		●	0.4	3.5	mV
$\Delta V_{OS}/\Delta T$	Input V_{OS} Drift		●	2.0		$\mu V/^\circ C$
I_{OS}	Input Offset Current		●	0.2	2.0	μA
I_B	Input Bias Current		●	± 0.5	± 2.5	μA
CMRR	Common Mode Rejection Ratio	$V_{CM} = -2.5V$ to $+3.5V$	●	65	85	dB
PSRR	Power Supply Rejection Ratio	$V_S = \pm 2.375V$ to $\pm 5.0V$	●	70	90	dB
A_{VOL}	Large Signal Voltage Gain	$R_L = 1k$, $V_O = \pm 3.0V$	●	55	90	V/mV
		$R_L = 100\Omega$, $V_O = \pm 3.0V$	●	5.0	14	
V_{OUT}	Output Voltage Swing	$R_L = 1k$	●	± 3.7	± 3.9	V
I_S	Supply Current		●	32	38	mA
	Shutdown Supply Current	Pin 5 at V^- , (Note 7)	●	1.5	2.5	
$I_{S/D}$	Shutdown Pin Current	Pin 5 at V^-	●	20		μA

ELECTRICAL CHARACTERISTICS $V_S = \pm 5V, 0^\circ C \leq T_A \leq 70^\circ C$, pin 5 open circuit unless otherwise noted.

SYMBOL	PARAMETER	CONDITIONS	LT1192C			UNITS
			MIN	TYP	MAX	
V_{OS}	Input Offset Voltage		●	0.4	3.0	mV
$\Delta V_{OS}/\Delta T$	Input V_{OS} Drift		●	2.0		$\mu V/^\circ C$
I_{OS}	Input Offset Current		●	0.2	1.7	μA
I_B	Input Bias Current		●	± 0.5	± 2.5	μA
CMRR	Common Mode Rejection Ratio	$V_{CM} = -2.5V$ to $+3.5V$	●	68	85	dB
PSRR	Power Supply Rejection Ratio	$V_S = \pm 2.375V$ to $\pm 5.0V$	●	70	90	dB
A_{VOL}	Large Signal Voltage Gain	$R_L = 1k, V_O = \pm 3.0V$	●	90	140	V/mV
		$R_L = 100\Omega, V_O = \pm 3.0V$	●	10	30	
V_{OUT}	Output Voltage Swing	$R_L = 1k$	●	± 3.7	± 3.9	V
I_S	Supply Current		●	32	38	mA
	Shutdown Supply Current	Pin 5 at V^- , (Note 7)	●	1.4	2.1	
I_{SPD}	Shutdown Pin Current	Pin 5 at V^-	●	20		μA

2

The ● denotes the specifications which apply over the full operating temperature range.

Note 1: A heat sink is required to keep the junction temperature below absolute maximum when the output is shorted.

Note 2: Exceeding the input common mode range may cause the output to invert.

Note 3: Slew rate is measured between $\pm 1V$ on the output, with a $\pm 0.3V$ input step.

Note 4: Full power bandwidth is calculated from the slew rate measurement: $FPBW = SR/2\pi V_p$.

Note 5: Settling time measurement techniques are shown in "Take the Guesswork Out of Settling Time Measurements," EDN, September 19, 1985. $A_V = -5, R_L = 1k$.

Note 6: NTSC (3.58MHz). For $R_L = 1k$, Diff $A_V = 0.1\%$, Diff Ph = 0.01° . Diff A_V and Diff Ph can be reduced for $A_V < 10$.

Note 7: See Applications section for shutdown at elevated temperatures. Do not operate the shutdown above $T_J > 125^\circ C$.

Note 8: AC parameters are 100% tested on the ceramic and plastic DIP packaged parts (J and N suffix) and are sample tested on every lot of the SO packaged parts (S suffix).

Optional Offset Nulling Circuit

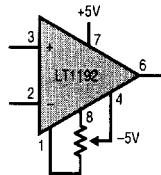

INPUT OFFSET VOLTAGE CAN BE ADJUSTED OVER A $\pm 20mV$ RANGE WITH A $1k\Omega$ TO $10k\Omega$ POTENTIOMETER.

LT1192-TA03

TYPICAL PERFORMANCE CHARACTERISTICS

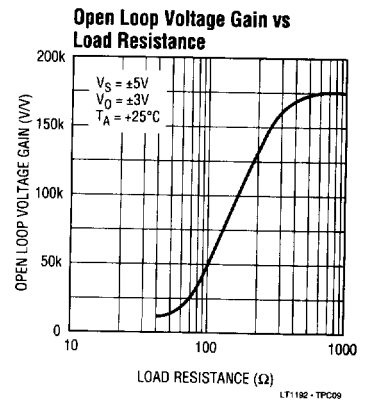
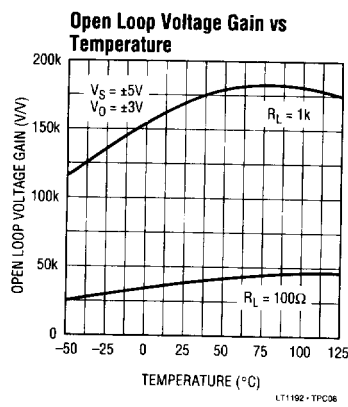
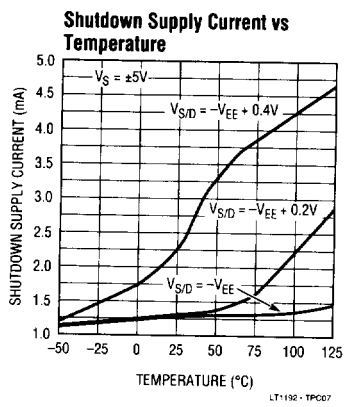
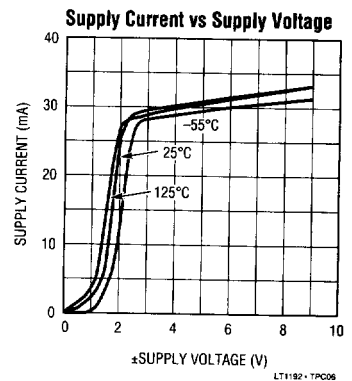
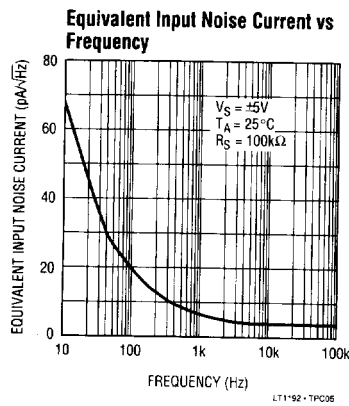
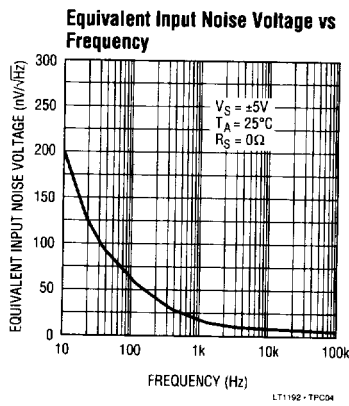
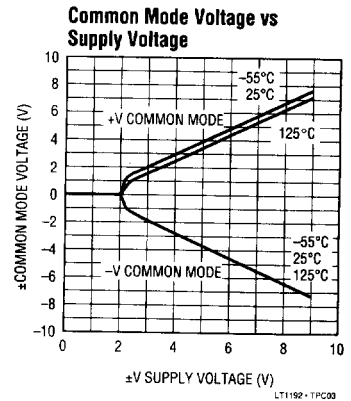
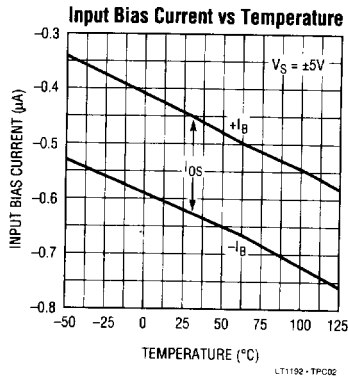
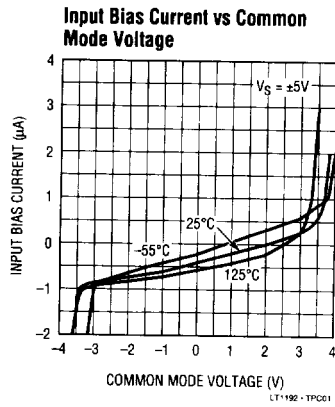

TYPICAL PERFORMANCE CHARACTERISTICS

Gain, Phase vs Frequency

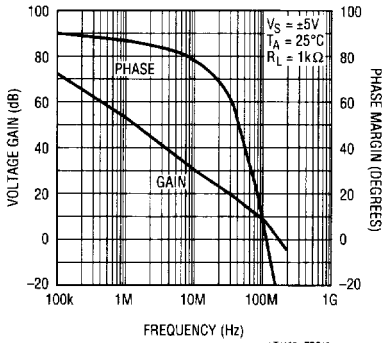

Gain Bandwidth Product vs Supply Voltage

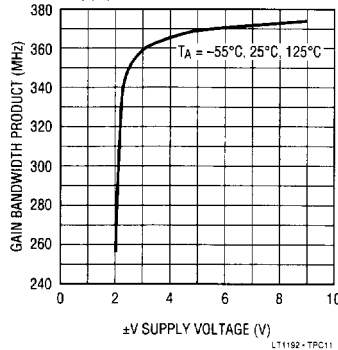

Output Impedance vs Frequency

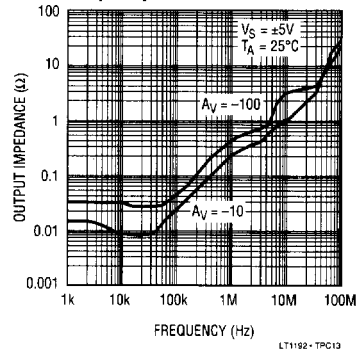

2

Gain and Phase Margin vs Temperature

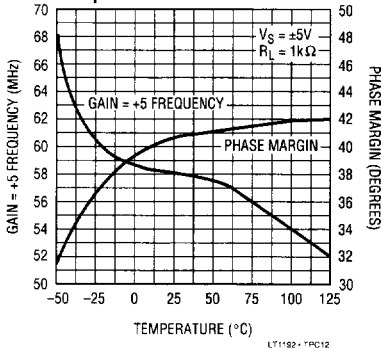

Common Mode Rejection Ratio vs Frequency

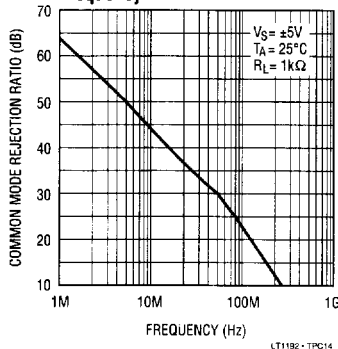

Power Supply Rejection Ratio vs Frequency

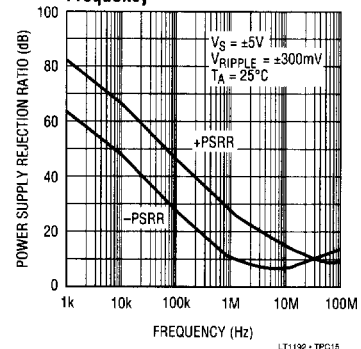

Output Short Circuit Current vs Temperature

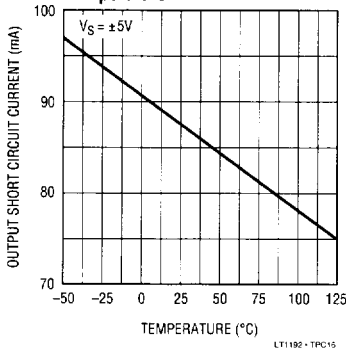

± Output Swing vs Supply Voltage

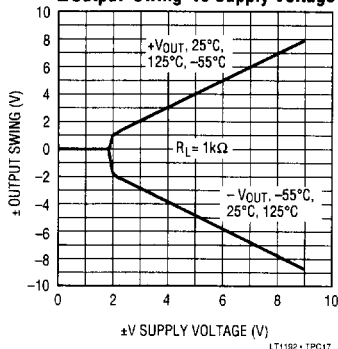

Output Voltage Swing vs Load Resistance

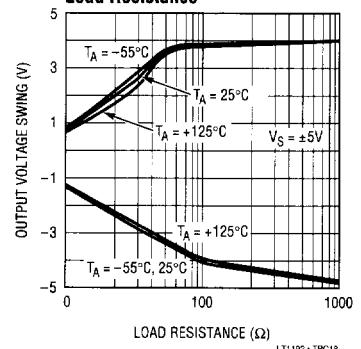

TYPICAL PERFORMANCE CHARACTERISTICS

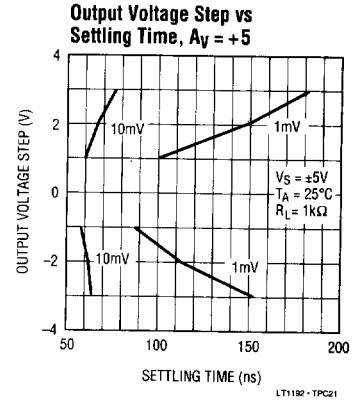
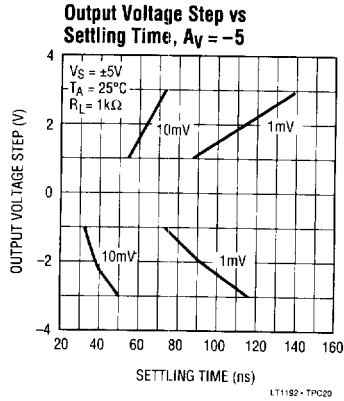
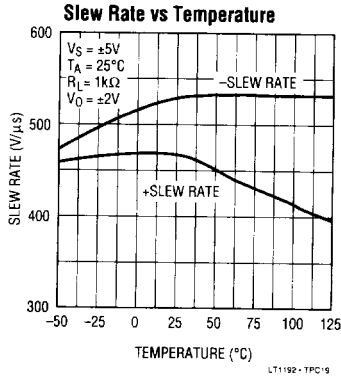

Large Signal Transient Response

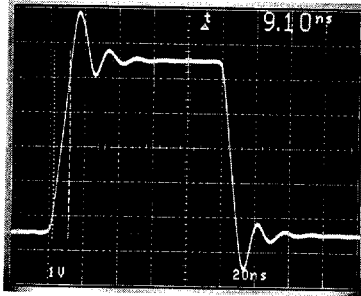

$A_V = +5$, $C_L = 10pF$ SCOPE PROBE

LT1192 - TPC22

Output Overload

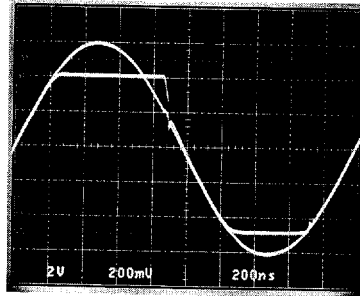

$A_V = +10$, $V_{IN} = 1.2Vp-p$

LT1192 - TPC24

Small Signal Transient Response

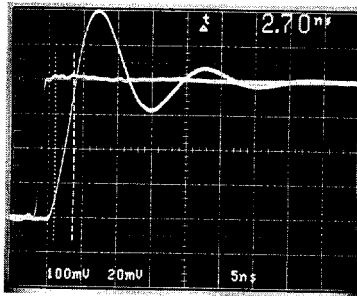

$A_V = +5$ SMALL SIGNAL RISE TIME, WITH FET PROBES

LT1192 - TPC23

APPLICATIONS INFORMATION

Power Supply Bypassing

The LT1192 is quite tolerant of power supply bypassing. In some applications a 0.1 μ F ceramic disc capacitor placed 1/2 inch from the amplifier is all that is required. A scope photo of the amplifier output with no supply bypassing is used to demonstrate this bypassing tolerance, $R_L = 1k\Omega$.

No Supply Bypass Capacitors

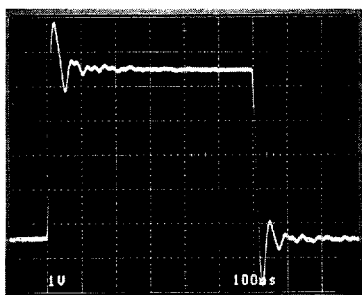

$A_V = -5$, IN DEMO BOARD, $R_L = 1k\Omega$
LT1192 - TA04

In most applications, and those requiring good settling time, it is important to use multiple bypass capacitors. A 0.1 μ F ceramic disc in parallel with a 4.7 μ F tantalum is recommended. Two oscilloscope photos with different bypass conditions are used to illustrate the settling time characteristics of the amplifier. Note that although the output waveform looks acceptable at 1V/div, when amplified to 1mV/div the settling time to 1mV is 4.132 μ s for the 0.1 μ F bypass; the time drops to 140ns with multiple bypass capacitors.

Settling Time Poor Bypass

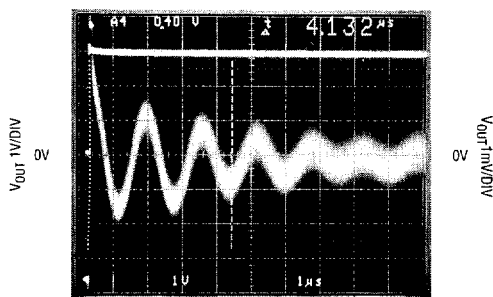

SETTLING TIME TO 1mV, $A_V = -1$
SUPPLY BYPASS CAPACITORS = 0.1 μ F

LT1192 - TA05

Settling Time Good Bypass

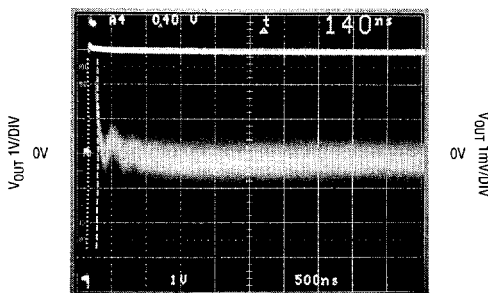

SETTLING TIME TO 1mV, $A_V = -1$ SUPPLY
BYPASS CAPACITORS = 0.1 μ F + 4.7 μ F TANTALUM

LT1192 - TA06

2

Cable Terminations

The LT1192 operational amplifier has been optimized as a low cost video cable driver. The ± 50 mA guaranteed output current enables the LT1192 to easily deliver 7.5Vp-p into 100 Ω , while operating on ± 5 V supplies, or 2.6Vp-p on a single 5V supply.

Double Terminated Cable Driver

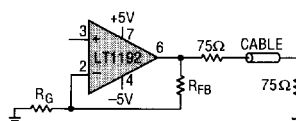

Cable Driver Voltage Gain vs Frequency

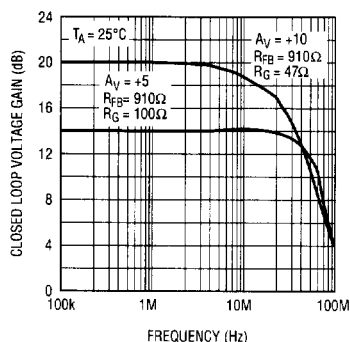

LT1192 - TA07

When driving a cable it is important to terminate the cable to avoid unwanted reflections. This can be done in one of two ways: single termination or double termination. With

APPLICATIONS INFORMATION

single termination, the cable must be terminated at the receiving end (75Ω to ground) to absorb unwanted energy. The best performance can be obtained by double termination (75Ω in series with the output of the amplifier, and 75Ω to ground at the other end of the cable). This termination is preferred because reflected energy is absorbed at each end of the cable. When using the double termination technique it is important to note that the signal is attenuated by a factor of 2, or 6dB. For a cable driver with a gain of +5 (op amp gain of +10) the -3dB bandwidth is 56MHz with only 0.25dB of peaking.

Using the Shutdown Feature

The LT1192 has a unique feature that allows the amplifier to be shutdown for conserving power, or for multiplexing several amplifiers onto a common cable. The amplifier will shutdown by taking pin 5 to V^- . In shutdown, the amplifier dissipates 15mW while maintaining a true high impedance output state of $15\text{k}\Omega$ in parallel with the feedback resistors. The amplifiers must be used in a non-inverting configuration for MUX applications. In inverting configurations the input signal is fed to the output through the feedback components. When the output is loaded with as little as $1\text{k}\Omega$ from the amplifier's feedback resistors, the amplifier shuts off in 400ns. This shutoff can be under the control of HC CMOS operating between 0V and -5V .

Output Shutdown

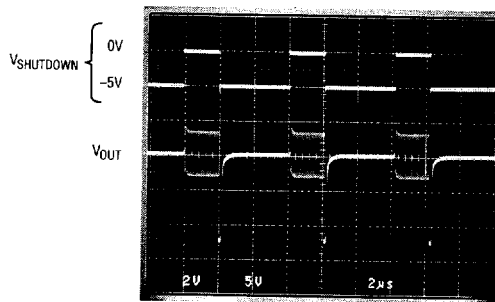

1MHz SINE WAVE GATED OFF WITH SHUTDOWN PIN. $A_V = +10$, $R_L = 1\text{k}$

LT1192 - TA08

The ability to maintain shutoff is shown on the curve Shutdown Supply Current vs Temperature in the Typical

Performance Characteristics section. At very high elevated temperatures it is important to hold the shutdown pin close to the negative supply to keep the supply current from increasing.

Operating with Low Closed Loop Gains

When using de-compensated amplifiers it should be realized that peaking in the frequency domain, and overshoot and ringing in the time domain occur as closed loop gain is lowered. The LT1192 is stable to a closed loop gain of +5, however, peaking and ringing can be minimized by increasing the closed loop gain. For instance, the LT1192 peaks +5dB when used in a gain of +5, but peaks by less than 0.5dB for a closed loop gain of +10. Likewise, the overshoot drops from 50% to 4% for gains of +10.

Small Signal Transient Response

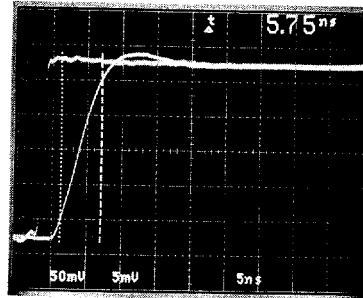

$A_V = +10$ SMALL SIGNAL RISE TIME, WITH FET PROBES

LT1192 - TA09

Closed Loop Voltage Gain vs Frequency

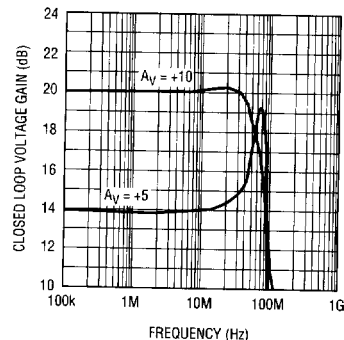

LT1192 - TA10

APPLICATIONS INFORMATION

Driving Capacitive Load

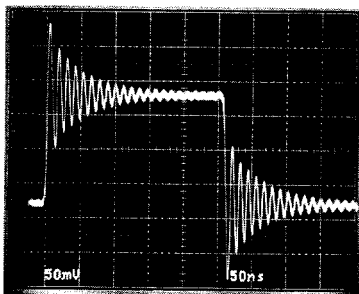

$A_V = -5$, IN DEMO BOARD, $C_L = 50\text{pF}$

LT1192-TA11

Driving Capacitive Load

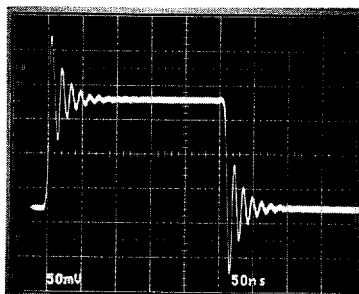

$A_V = -5$, IN DEMO BOARD, $C_L = 50\text{pF}$ WITH
20Ω ISOLATING RESISTOR

LT1192-TA12

SIMPLIFIED SCHEMATIC

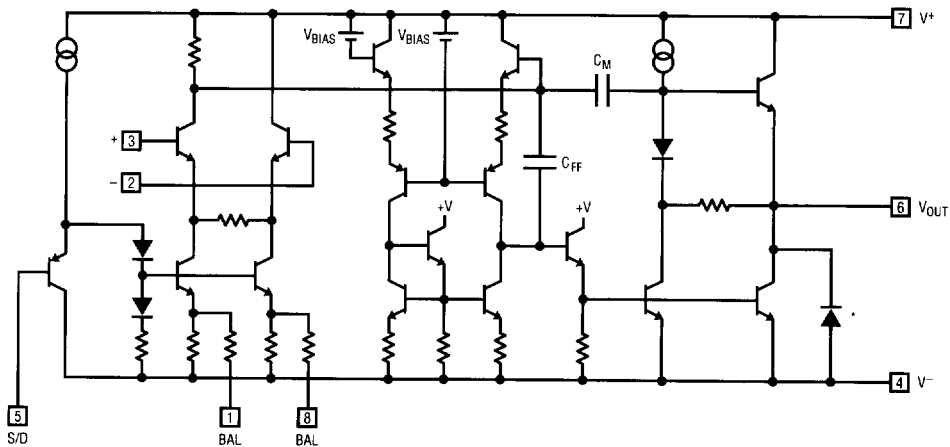

* SUBSTRATE DIODE, DO NOT FORWARD BIAS

LT1192-TA14

APPLICATIONS INFORMATION

Murphy Circuits

There are several precautions the user should take when using the LT1192 in order to realize its full capability. Although the LT1192 can drive a 50pF load, isolating the capacitance with 20Ω can be helpful. Precautions primarily have to do with driving large capacitive loads.

Other precautions include:

1. Use a ground plane (see Design Note 50, High Frequency Amplifier Evaluation Board).
2. Do not use high source impedances. The input capacitance of 2pF, and $R_S = 10k\Omega$ for instance, will give an 8MHz -3dB bandwidth.
3. PC board socket may reduce stability.
4. A feedback resistor of 1kΩ or lower reduces the effects of stray capacitance at the inverting input.

2

Murphy Circuits

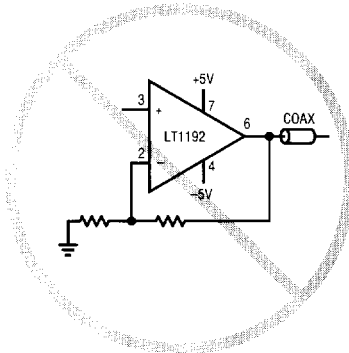

An unterminated cable is a large capacitive load

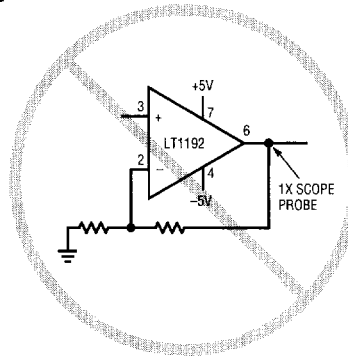

A 1X scope probe is a large capacitive load

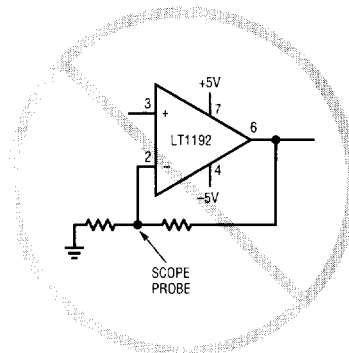

A scope probe on the inverting input reduces phase margin

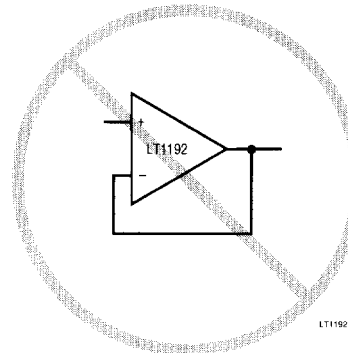

LT1192 is stable for gains $\geq +5V/V$

LT1192 - TA13